

CSP-dot Series Specification

PDM70

24V-10mm



【General description】

- DMX512 white strip, 10 pixels per meter, 65536 grey scale, IC model: UCS512H4LB
- The EFW process has a unique structure, using special profiles, does not require adhesive backing, and is easy to install
- Side-exit cable plug, seamless lighting with no dark spots
- Operating Temperature, Ta: -40~60°C; Tc: 75°C (max)
- 5 years warranty

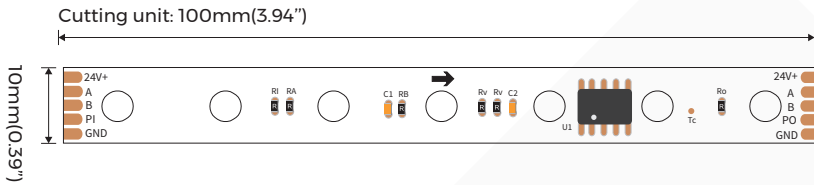
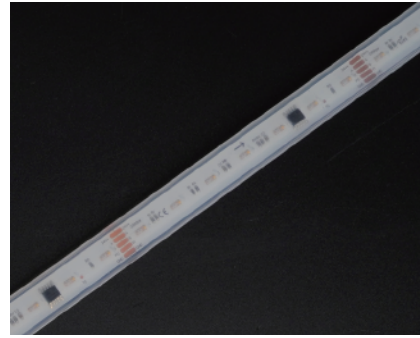

【Dimension】

- | | |
|----------------------------------|--|
| Input voltage: DC24V | Max.length: 5000mm(16.4') |
| CRI: 90 | Cutting unit: 100mm(3.93") |
| Max.power: 13.2W(1m) | LED pitch: 14.28mm(0.56") |
| Power range: 10.8~13.2W(1m) | Min. bend diameter: Φ 60mm(2.36") |
| Rated current: 0.5A(1m) | Mounting: 3M tape |
| Typical Power: 12W(1m) | Copper foil: 3oz |
| IP: IP20/IP67 | |
| On-off times: 10000 (test times) | |
| Warranty: 5years | |

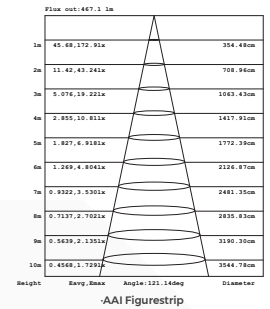
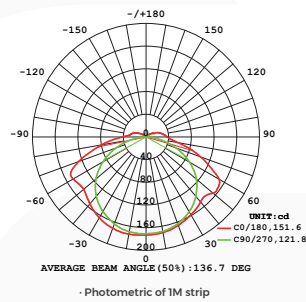

【Photo-electric Parameters】



CRI	Color	CCT	Lumen(lm/m)	Lumen(lm/ft)	lm/W	ErP 2019
>90	SW	2700K	750	228	62	G
>90	WW	3000K	790	240	66	G
>90	NW	4000K	820	250	68	G
>90	W	6500K	825	251	68	G

- 1.The tolerance of output data can be vary up to 15%.
- 2.the output data tested according to IES TM-30-15.
- 3.the output data is based on IP20/Imeter, data of 5m in only for reference.
- 4.IP protection process leads changes to size, CCT and luminous flux.

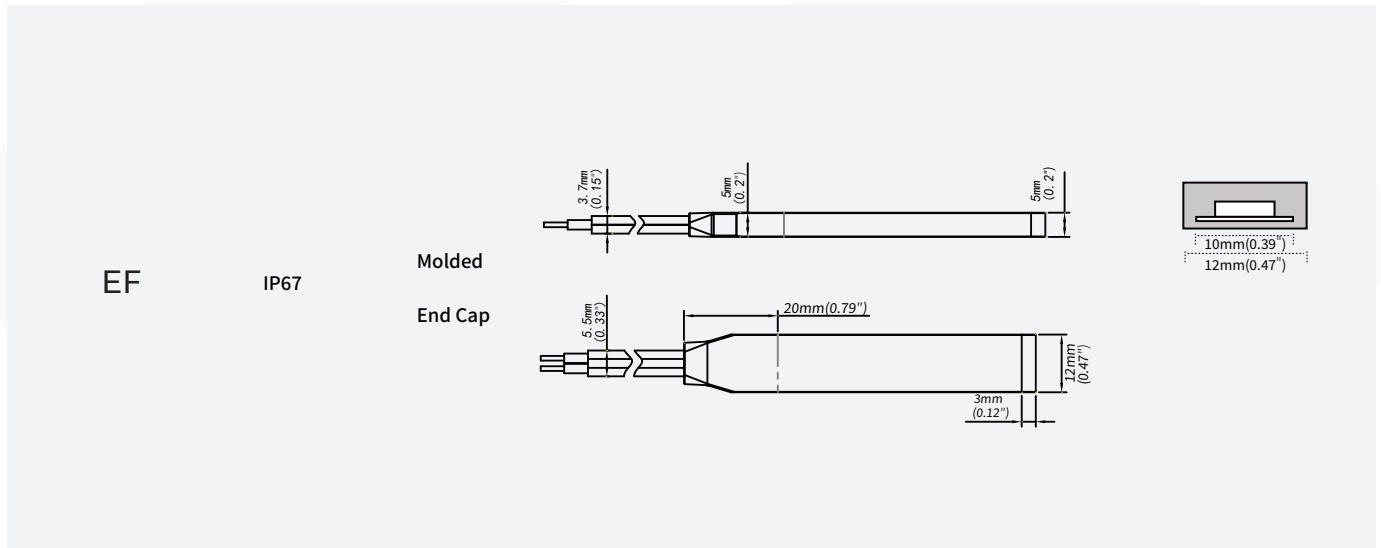
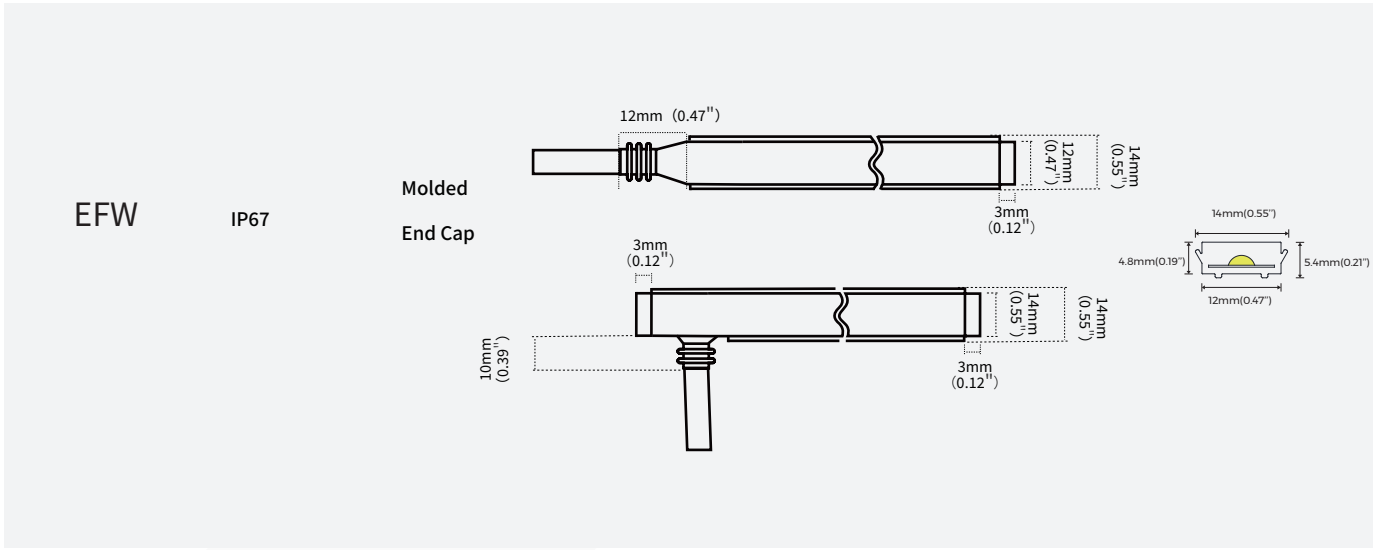









【IP process information】



【Electronic & output data】

IP Process	Picture	Picture description	Size	optional CCT/color for finished product	lumen output rate
NO		No proof	10mm*1.7mm	2700K/3000K/4000K/6500K	100%
EFW		No proof	14mm*5.4mm	2700K/3000K/4000K/6500K	86%
EF		No proof	12mm*5mm	2700K/3000K/4000K/6500K	86%

[Product Solutions]

Name	Picture	Code	coding	description
Alumina carrier		/	CLS10EFW-12050100	size:L1000*W15.4*H7.4mm
Aluminum clip		/	FLS10EFW-1205	size:L25*W15.4*H7.4mm
5P male connector wire		/	AS-FC-0021(0.25M) AS-FC-0022(0.5M) AS-FC-0023(2M)	suitable for RGBW/DMX led strip Wire lengths are optional: 0.25M/0.5M/2
5P female connector wire		/	AS-FC-0024(0.25M) AS-FC-0025(0.5M) AS-FC-0026(2M)	suitable for RGBW/DMX led strip Wire lengths are optional: 0.25M/0.5M/2
5P T-Connection Wire		/	AS-FC-0030	suitable for DMX led strip Wire length 150mm
Fixed Clip		94-02-00-0003	FSW10SA	Silicone clip, screw: PA 3*8mm, suitable for 10mm FPC,EF/ET strip
Silicone Plug Kit		94-02-00-0046	DT10EA-A	Silicone plug kit is suitable for 10mm board width, ET/EF series silicone extrusion light strip
Silicone stopper kit		94-02-00-0047	DW10EA-A	Silicone tail plug kit is suitable for 10mm board width, ET/EF series silicone extrusion light strip
Mounting groove		94-02-00-0025	CVT10EA-14100100	Transparent PVC mounting groove,suitable for 10mm FPC,silicone extruded EF/ET strip
Stopper glue		94-16-03010001	AS-PG-0003	Silicone gel,suitable for ET/EF/EG waterproof LED strip
Controller		/	K-8000C	Power supply: DC 5V-24V input Power consumption: 5W Working temperature: Ta:0-20 ℃~0+85 ℃

[Packing]

Colors brand package(NONA)

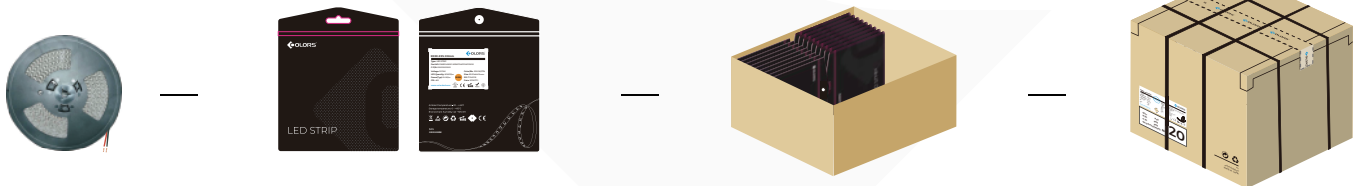

General customized package(EF/EFW)

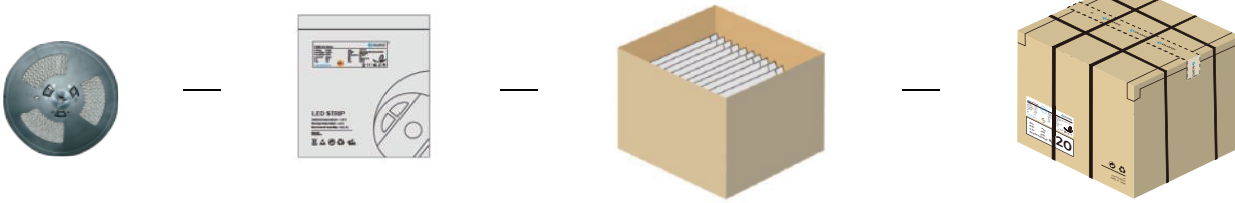

IP Process	Product size(mm)	Product quantity (m/reel)	Product quantity (m/case)	Product net weight(kg)	Net weight per box(kg)	Gross weight(kg)	Package size (cm)
NO	5000*10*1.7	5	300	0.13	7.6	8.8	41*41*26
EFW	5000*14*5.4	5	125	0.55	12.8	13.9	29*29*56
EF	5000*12*5	5	200	0.45	18	19.8	41*41*26

Remark: data with 10% tolerance

【Precautions】

- Please drive the led strip with 24VDC isolated power, and the ripple of the constant voltage source should be less than 5%.
- Please do not bend the strip into an arc with a diameter less than 60mm to ensure the longevity and reliability.
- Do not fold it in case any damage of LED beads.
- Do not pull the power wire hard to ensure the longevity. Any Crash may damage the LED light is prohibited.
- Please make sure the wire is connected to the anode and cathode correctly. The power output should be consistent with the voltage of the strip to avoid damage.
- LED lights should be stored in dry, sealed environment. Please only unpack it before usage. Ambient temperature: -25°C~40°C. Storage temperature: 0°C~60°C. Please use the strips without waterproof within indoor environment with humidity less than 70%.
- Please be careful during operation. Do not touch the AC power supply in case of electric shock.
- Please leave at least 20% power for the power supply during using to ensure there is enough power supply to drive the product.
- Do not use any acid or alkaline adhesives to fix the product (e.g.: glass cement).
- Do not scratch the product when IP process of the product is NA. Ultraviolet rays will damage the nano-layers on the product and seriously affect the life of the product.